

1 2 3 4 5

A

B

C

D

A

B

C

D

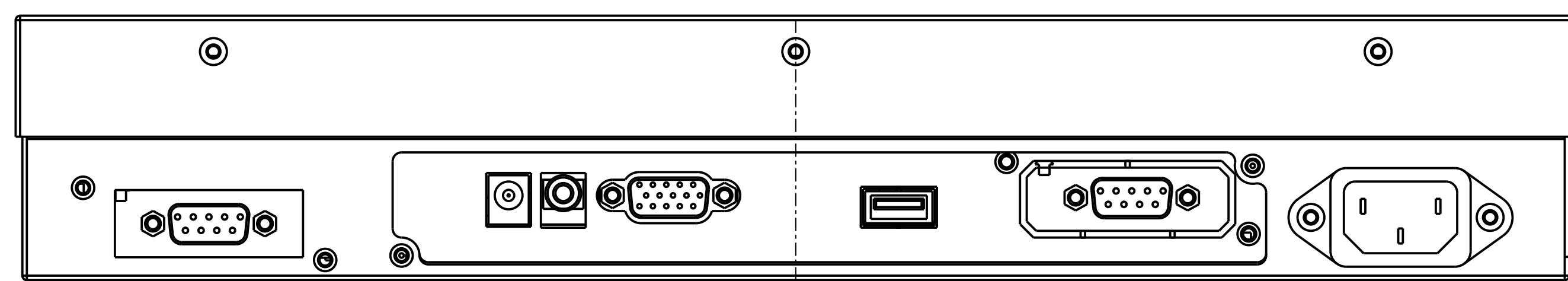
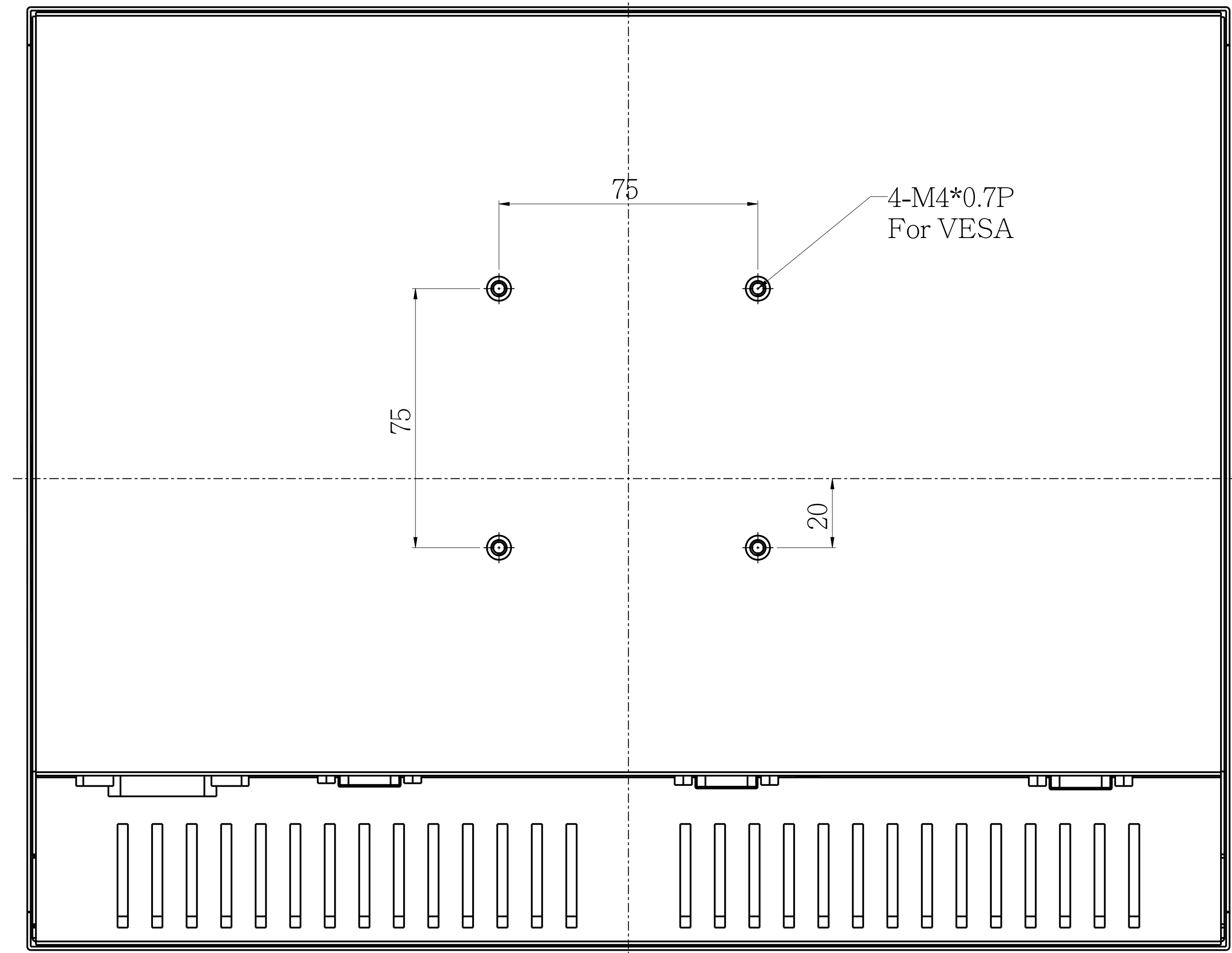
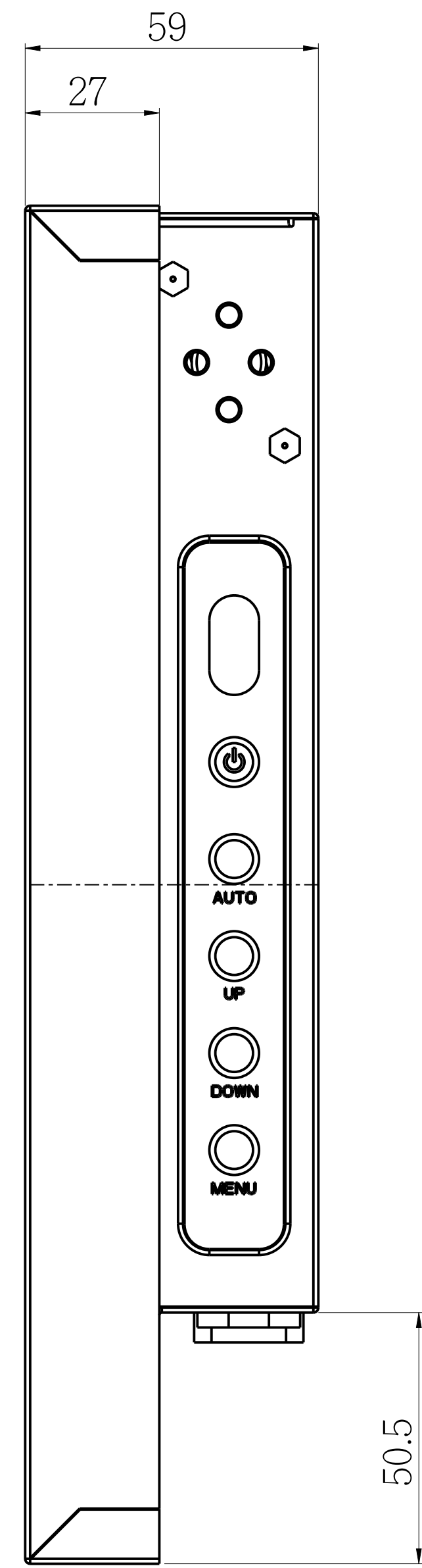
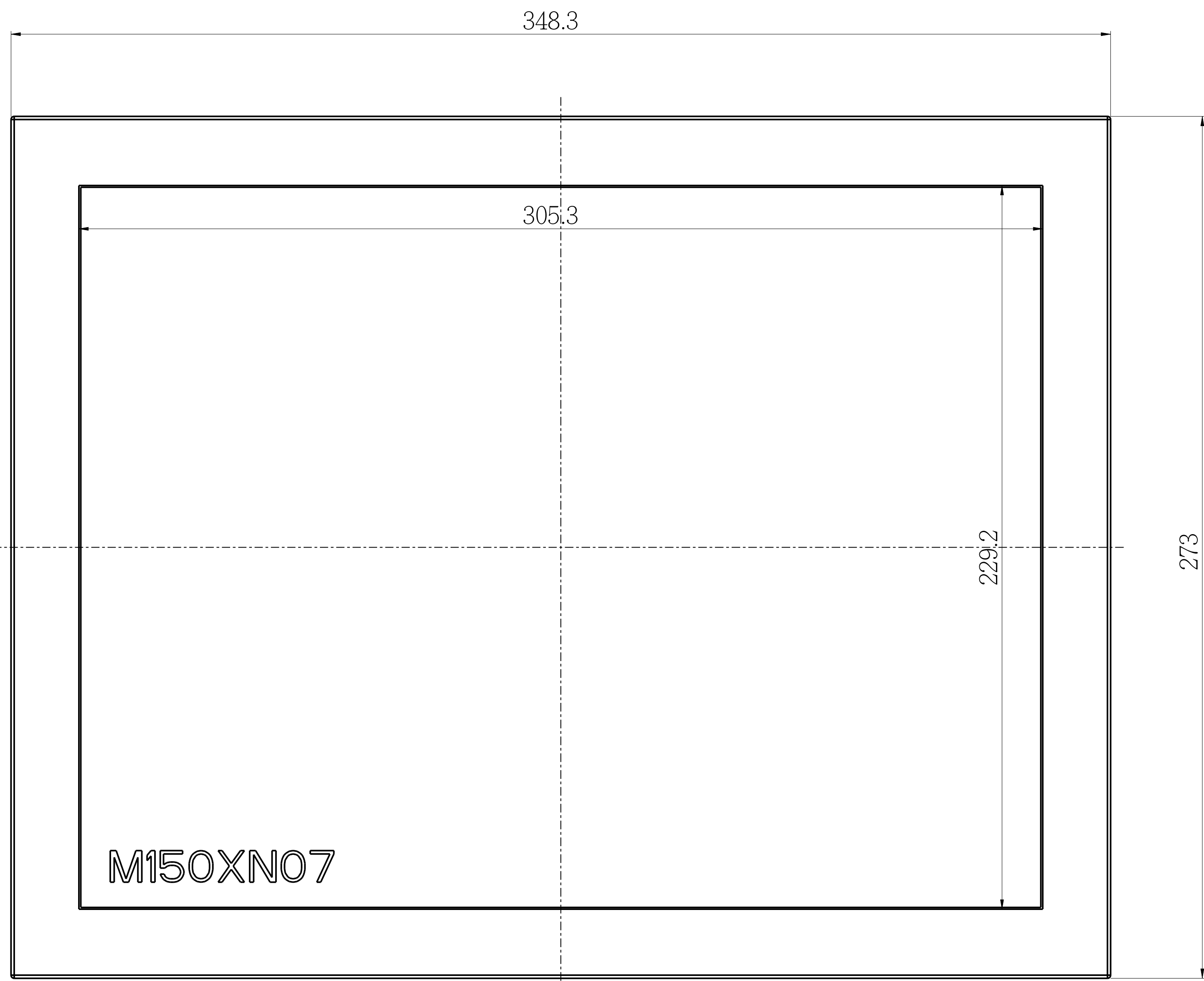

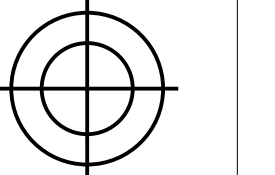
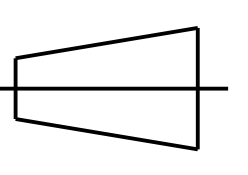
AD/BOARD		MODEL CH1505										
INVERTER												
KEY PAD												
PANEL:		VERSION	MATERIAL	METAL	DATE	2012-Mar-01	PART NAME	ASSEMBLY			SCALE	1.000
		V1					APPROVED	DRAWN	Jack	UNIT	MM	

1 2 3 4 5